

INSTRUCTION MANUAL

for

THE

NATIONAL

HRO

COMMUNICATION RECEIVER

Designed to meet the most exacting demands of the more advanced communication service



Price 10c

While intended primarily as an operating instruction manual, it is hoped that this booklet will also serve to better acquaint the owner of a National HRO high-frequency communication receiver with the engineering details of its design. Only by a proper appreciation of some of the many unusual design features of this new receiver is it possible for the operator to secure the unusually high degree of performance that we have built into the HRO.

We express indebtedness to the American Radio Relay League for permission to reprint, in part, articles published in past issues of their official organ, *QST*.

NATIONAL COMPANY, INC.

Malden, Mass., U. S. A.

Copyright 1939



The HRO

Amateur Communications Receiver

THE HRO receiver is a high-frequency super-heterodyne employing nine tubes, as follows:

First R.F.....	58	or 6D6
Second R.F.....	58	or 6D6
First Detector.....	57	or 6C6
High Frequency Oscillator.....	57	or 6C6
First I.F.....	58	or 6D6
Second I.F.....	58	or 6D6
Diode Detector, AVC, First Audio.....	2B7	or 6B7
Second Audio.....	2A5	or 42
Beat Frequency Oscillator.....	57	or 6C6

Unless otherwise specified, all models are equipped with 6.3-volt tubes, for either A.C. or battery operation. The 2½-volt tubes can be used if desired, since the two types are interchangeable, but the 6.3-volt tubes are to be preferred.

For A.C. operation, the receiver is adjusted to give best performance with the National type 697 AB power unit, which delivers 230 volts at 75 milliamperes, and 6.3 volts at 3.1 amperes.

The battery model, type HRO-B, is adjusted for maximum performance with a plate potential of 180 volts at a current drain of approximately 55 milliamperes. Normal operation from A.C. lines with the HRO-B can be secured by the employment of a National type No. 5886 power pack, a unit which, under load, delivers approximately 170 volts D.C. at 50 milliamperes and 6.3 volts A.C. at 3.1 amperes.

All voltage dividers, bias requirements, etc. are built into the receiver.

Other power units may be used provided they will fulfil these specifications closely, but it is important that an adequate heater supply be furnished to compensate for the voltage drop in the heater leads of the power supply cable.

The HRO receiver has been designed around and tested with RCA or Sylvania tubes; consequently, we can vouch for its performance only when these tubes are used.

Antenna

The input circuit of the HRO is arranged for operation with either the doublet type or the single-wire type of antenna. There are two input binding posts, marked "ANT" and "GND." When using a single-wire antenna, the lead-in should be connected to the antenna post and the short flexible lead, which is connected to the chassis near the ground post, should be clamped

under the "GND" terminal. An external ground connection may or may not be necessary, depending upon the installation. The ground is usually desirable when receiving wavelengths above 100 meters, but for wavelengths below 50 meters, the use of a ground may actually weaken signals. Doublet antenna feeders should be connected directly to the input terminals and the flexible ground connection, mentioned above, is not used at all.

The input impedance of the receiver varies over the total frequency range but averages about 500 ohms.

Output Circuit

The plate circuit of the output tube is brought to the output tip jacks located at the rear left-hand side. There is no output transformer in the receiver.

The speaker requirements are not at all critical, but tone quality will, of course, depend almost entirely upon speaker characteristics. A good magnetic speaker will be satisfactory, provided it is capable of carrying the plate current of the output tube (about 30 ma.). Many magnetic speakers will require a filter system, however, and such a filter may consist of a 1-to-1 transformer, or a 30-henry choke and a 1-mfd. condenser.

Dynamic speakers are, in general, superior to the magnetic types, but if these are used some provision must be made for field excitation, since this power cannot be obtained either from the receiver or the power unit. For this reason, the permanent magnet type of dynamic speaker is recommended, no field excitation being required. The output impedance of the HRO is 7000 ohms, and a dynamic speaker must, of course, have a suitable built-in coupling transformer of 7000-ohm input impedance.

A headphone jack is located on the front panel, just below and to the right of the "S"-meter. This jack is wired into the output of the pentode section of the 6B7. When the phones are plugged in, the signal input to the last tube is completely disconnected. It is important, however, that the plate circuit of the output tube be completed at all times. If the speaker is to be disconnected, a jumper must be inserted in the tip jacks to connect them together. If this precaution is neglected, the output tube may be seriously injured.

SCHEMATIC DIAGRAM — TYPE H.R.O. RECEIVER.

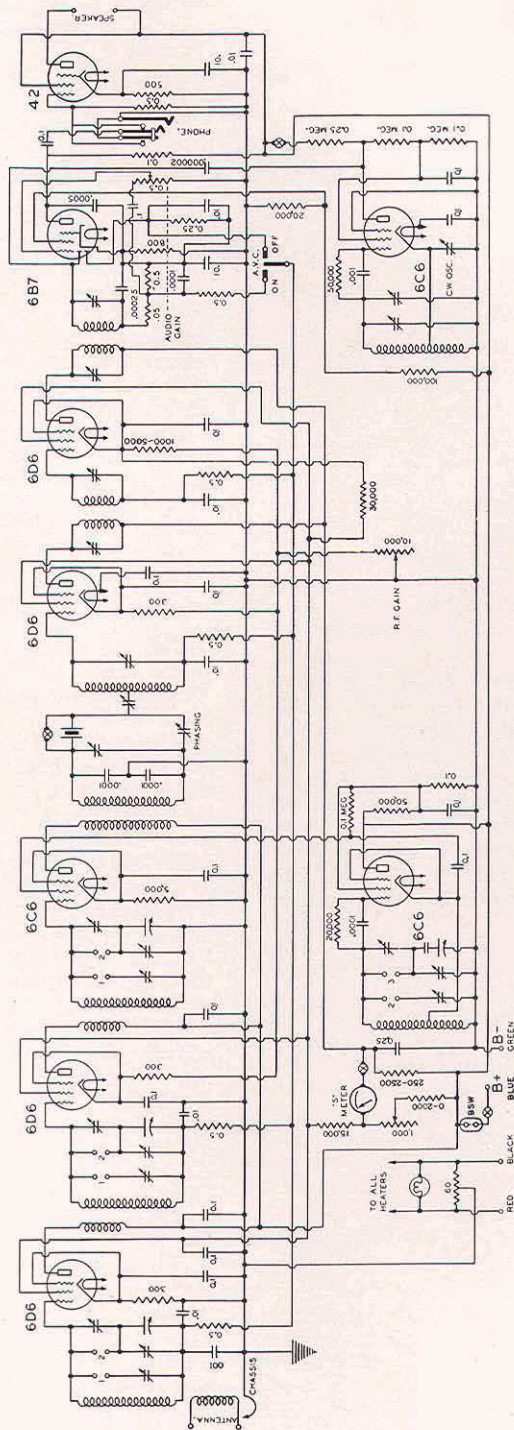

Controls

The main tuning dial is located near the center of the front panel and operates the 4-gang tuning condenser. Full details of the tuning arrangement will be found in the last section of this booklet, which is reprinted from an article originally appearing in QST.

Starting at the top right-hand side of the front panel, the uppermost knob is the Variable Selectivity Control of the Single-Signal Crystal Filter. With the crystal filter in use, minimum selectivity will be found with the pointer nearly vertical. Rotating the knob in either direction from this point will increase the selectivity. When the filter is not in use, the knob should be set at the point giving maximum volume and sensitivity.

Immediately below the Selectivity Control is the Phasing Control and the Crystal Filter Switch. When this control is rotated to 0, the crystal filter is disconnected. When the control is at any other setting between 1 and 10, it acts as a phasing condenser for balancing the crystal bridge circuit, eliminating heterodynes, etc. The action of these two controls is explained in detail in Part 2 of the Alignment Section.

The switch below the phasing control is connected in the B+ lead of the receiver and its purpose is to shut off the receiver during periods of transmission OR WHEN CHANGING COILS. This last function is important. Series connected with the B+ switch and mounted at the rear of the chassis is a pair of contacts, BSW, intended for use with relay control of the receiver.

The bottom control on the right-hand side is an R.F. Gain Control, connected to the second R.F. tube and to the two I.F. tubes.

At the bottom left-hand side of the front panel is located the C.W. Oscillator Switch and Vernier Tuning Control. The c.w. oscillator is used to obtain an audible beat note when receiving c.w. signals or to locate the carrier of weak phone and broadcast stations. After the phone carrier has been found, the c.w. oscillator is, of course, turned off.

The switch just above the c.w. beat oscillator dial is for turning the AVC on or off. AVC is disconnected with the toggle thrown to the right.

Above this switch is the Audio Gain Control, which is wired into the output of the diode detector and serves, therefore, to control audio volume when using either headphones or speaker.

The S-meter for indicating carrier intensity of signal strength is in the upper left-hand corner. Just below it, and to the left, is a push-switch which connects the meter in the circuit.

Operating Instructions

Phone or Broadcast Reception

In receiving phone signals, the AVC may or may not be used, as desired. If it is not used, we suggest operating the audio gain control about

halfway on and controlling the sensitivity with the R.F. gain control. If the operator prefers a "quiet" receiver, the audio control may be operated at 1 or 2. If AVC is used (left-hand toggle thrown to the left), the R.F. gain control may be turned all the way on; i.e., to 10; and the volume controlled by the audio gain control only. The setting of the two gain controls is largely a matter to be determined by the preference of the operator and by receiving conditions. If, for instance, local noise or atmospheric static is high, it will be desirable to retard the R.F. gain control when using AVC so that the sensitivity of the receiver will be held to a definite maximum. If the c.w. oscillator is to be used for locating carriers, as mentioned above, the AVC switch must be in the off position (to the right). Turning on the c.w. oscillator with the AVC on will block the receiver, making reception of anything but extremely strong signals impossible.

C.W. Reception

When receiving c.w. signals, the c.w. oscillator must be turned on and the AVC switch turned off. Best signal-to-noise ratio will usually be obtained by retarding the audio gain control considerably and controlling sensitivity with the R.F. gain control. Turning on the c.w. oscillator switch will, of course, result in a considerable increase in circuit noise. When the control is turned back and forth, the characteristic pitch of this noise will change. When the characteristic pitch is fairly high, the semi-"single-signal" properties of the receiver are very pronounced, one side of the audio beat note being several times as loud as the other.

Phone Reception Using the Crystal Filter

The use of the crystal filter in phone reception is recommended particularly when the operator must contend with heavy interference, static, heterodynes, etc. Since such conditions prevail at most times in the amateur phone bands, the filter will be found particularly useful to amateur phone operators. To receive a phone signal when using the crystal filter, the filter is switched in by means of the phasing control and the phasing dial set at approximately mid-scale. The selectivity control is then adjusted for minimum selectivity, as indicated by maximum noise as the control is rotated back and forth. All phone signals will be greatly reduced in volume, making it necessary to advance both audio and R.F. gain controls. The signals may then be tuned in in the usual manner, but it will be found that the selectivity is very high, with the result that all audio frequency side bands above a few hundred cycles are comparatively weak. Normally, this would result in low intelligibility of the received signal, but since the background noise, static, etc. have been correspondingly reduced, the net result is usually an improvement.

The principal advantage of the crystal filter,

however, is its ability to eliminate heterodynes. Suppose, for instance, a signal has been carefully tuned in with reasonably good intelligibility and during the transmission an interfering station comes on, causing a bad heterodyne, inverted speech, etc., ordinarily the desired signal would be "smeared," but careful adjustment of the phasing condenser will eliminate the heterodyne and the interfering station, in most cases, completely. Intelligibility will remain practically as good as before the interfering station came on.

From a practical standpoint, it is important that the crystal filter be used most of the time where such interference is apt to be encountered, as it is almost impossible to switch on the crystal filter and re-tune the desired signal through the heterodyne. The phasing adjustment will remove one signal only. If another interfering station comes on, however, only one heterodyne will be present, instead of the several resulting from three station carriers beating together.

C.W. Reception with the Crystal Filter

To use the crystal filter for c.w. reception, the filter is switched in by means of the phasing control and the phasing condenser set about mid-scale. The AVC switch must be off and the c.w. oscillator turned on. Advancing the R.F. and audio gain controls will result in a hollow, ringing sound the pitch of which will depend upon the setting of the c.w. oscillator dial. The actual pitch is not important as long as it is near the middle of the audio range, where the loudspeaker or phones have good sensitivity.

When a signal is picked up, it will be found that as the receiver is tuned slowly across the carrier the beat note will be very sharply peaked at the same pitch as that of the ringing noise, previously mentioned. All other parts of the beat note will be extremely weak and, furthermore, this peak will be found to occur on only one side of the audio beat note. The sharpness of the peak is determined by the selectivity control (upper right-hand knob). At maximum selectivity, the peak is so sharp that it may be hard to find, whereas at minimum selectivity the peak will be very broad. If a signal is being received, after having been properly tuned in, and an interfering station comes on, the resulting heterodyne and interference may be eliminated by adjustment of the phasing condenser. This phasing adjustment is effective in eliminating interference regardless of the setting of the selectivity control.

S-Meter

The S-meter serves to indicate the strength of a received signal. It is calibrated from 1 to 9 in arbitrary units which correspond, roughly, to the definition of the nine points of the "S" scale of the R-S-T system of amateur signal reports.

Probably no two operators will agree on just how strong a signal must be to warrant an S-9 report. After making measurements on a large

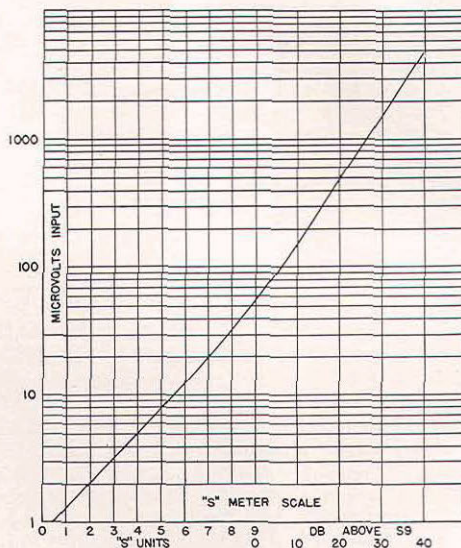

number of amateur signals, the present meter scale was chosen and we believe it will provide a good practical means of giving accurate reports. The accompanying curve shows the relation between average meter readings and the actual signal input to receiver in microvolts and from this curve it will be noted that each "S" unit is equal to a change of approximately 4 db. The 40 db. range above the S-9 level is used for comparative checks on extremely strong signals.

Figure 3 shows the "S-meter" network connected in the B supply circuit to the R.F. and I.F. stages. Actually the meter is the indicator of a bridge circuit, three legs of which are fixed resistors, and the fourth (variable) leg the plate circuits of the a.v.c. controlled tubes. The bridge is balanced by means of the manual R.F. gain control, which, through its action of indirectly changing the plate resistance of the tubes, automatically adjusts the R.F. and I.F. gain to a predetermined level at the same time that the meter is brought to zero. The strength of the incoming signal is, therefore, accurately indicated by the action of the A.V.C. circuits in controlling high frequency gain.

Before making a measurement on a signal, certain adjustments must be made. Since the meter is actuated by the amount of signal reaching the second detector, it is obviously necessary that the receiver be adjusted to have a predetermined amount of amplification between the antenna and second detector. To adjust the amplification to the proper value, the AVC switch must be off, the c.w. oscillator off, the crystal filter off, and the selectivity control set for maximum sensitivity. Now press the meter switch and advance the R.F. gain control until the meter comes to 0. The R.F. gain dial will read about $9\frac{1}{2}$. The receiver is now adjusted and

the strength of any signal may be measured by throwing the AVC switch on and tuning for maximum meter deflection. The audio gain control does not have any effect on the R.F. adjustments or upon the meter reading, so that it may be retarded as much as necessary to prevent audio overload when making the preliminary adjustments.

If the signal being measured is extremely strong, however, or if local noise is exceptionally high, it may be impossible to bring the meter to 0. In this case, it is necessary to detune the receiver from the signal or to disconnect the antenna. The above procedure will hold true when checking either phone or c.w. stations. It is, however, impossible to obtain a continuous check on c.w. signals, as the beat oscillator must be off.

If it should happen that the S-meter network gets out of balance, the alignment procedure is as follows. Disconnect the antenna and turn off the AVC, set the R.F. gain control at $9\frac{1}{2}$, then, by means of a screw driver, adjust the control No. 17 (as shown in the top view) until the meter reads 0. This control is located in the chassis in back of the meter near the antenna binding post.

Coil Ranges

Four plug-in coil assemblies are supplied as standard equipment for the HRO receiver, each

assembly consisting of three R.F. coils and one oscillator coil, all individually shielded and provided with built-in trimmer condensers. Calibration curves are mounted on the front of each assembly.

The four assemblies cover all frequencies between 1.7 and 30 megacycles, the division being as follows:

1.7 to 4.0 mc.
3.5 to 7.3 mc.
7.0 to 14.4 mc.
14.0 to 30.0 mc.

Inspection of the coil terminal panels will show several small rectangular metal pieces. There are two of these pieces or terminal blocks on each of the coil panels. A small flat-head machine screw will be found in the left-hand terminal block of each coil, looking at the assembly from the front. With the screws in the left-hand position, the coil range will be that shown in the left-hand, or general coverage, chart. If it is desired to change the calibration to amateur band-spread, as shown on the right-hand chart, it is only necessary to move the four screws to the right-hand terminal block of each coil.

A complete description of the coils, tuning condensers, and the range changing system, is given in the last section of this booklet.

In addition to the coils furnished as standard equipment, other assemblies are available, covering frequencies from 2.05 mcs. to 50 kc. and are listed on the back cover of this manual.

Alignment and Service Data

THE four high-frequency coil assemblies are aligned in the laboratory to the individual receiver with which they are to be used. No coil adjustments of any kind should be necessary after the receiver is put into operation, but if coils are purchased separately the alignment should be checked in accordance with the following procedure.

The coil panel screws must be in the left-hand terminal blocks to give the full coverage range, as described in the preceding section. The tuning dial is turned to approximately 490 and a frequency meter, or accurate test oscillator, is set to the frequency indicated by the general coverage calibration chart. This will, incidentally, always be near the high-frequency edge of some amateur band. The oscillator coil trimmer, shown on the top view of the receiver as No. 8, is then adjusted so that the dial reading checks the calibration curve. Trimmers Nos. 2, 4 and 6 are then adjusted for maximum sensitivity. In adjusting these three trimmers, no signal is necessary, as the correct adjustment is that which will give maximum background or tube noise. This background noise should be fairly loud when the R.F. and audio gain controls are fully advanced,

the crystal filter being switched off. The tuning dial should then be rotated to the low-frequency end of the range. The background noise should not vary greatly as the dial is being turned. If it does, however, poor ganging is indicated.

The ganging is checked by pressing the outside rotor plate of the oscillator condenser sideways toward the stator, but not far enough to short the condenser. If sensitivity is increased, more inductance is needed in the oscillator coil. On the two low-frequency coil assemblies oscillator inductance is increased by loosening the nut which holds the inductance trimmer disc, inside the oscillator coil, so that the disc may move toward the back of the coil shield. If, however, sensitivity decreases when the oscillator rotor plate is bent toward the stator, the other condensers, particularly the first detector tuning condenser, should be tested the same way. If sensitivity decreases when the rotor plate is moved in, ganging is perfect and the general coverage range is completely adjusted. However, if sensitivity increases, the oscillator coil inductive trimmer must be adjusted to decrease inductance. In the case of the 14 to 30 and 7 to 14.4 megacycle coils, inductive trimming is accomplished by moving a

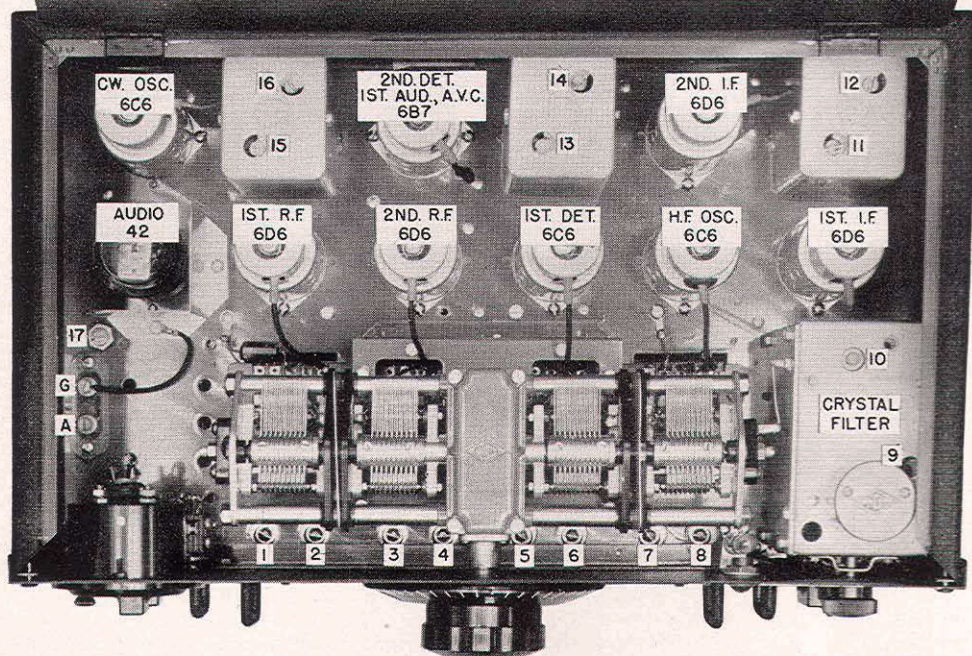

TOP VIEW HRO

loop of wire around the end of the oscillator coil. Bending this loop from right to left across the end of the coil form will increase inductance. After any change in the oscillator coil inductance has been made, it will be necessary to tune back to the high-frequency end of the range in order to readjust the No. 8 trimmer condenser. The procedure as outlined above is then repeated until the ganging is correct.

It will be found that the setting of the various trimmers, particularly the No. 8, is quite critical, but that the setting of the inductive trimmer is not at all sharp and, when making the inductance adjustment, the nut may be rotated a full turn for each trial.

In the case of the 14 to 30 megacycle coils, special care must be exercised to see that the oscillator is operating on the high-frequency side of the signal. Two points will be found when adjusting the No. 8 trimmer and of these, the correct one is on the counter-clockwise side. Furthermore, in adjusting the No. 6 trimmer of this coil assembly, there will be some interaction or interlocking between the first detector and oscillator circuits. In adjusting the No. 2 trimmer, it will be necessary to have the antenna connected with some signal or noise input.

The band-spread range may now be adjusted. It should be pointed out here that adjustments for the general coverage range will affect the band-spread range, but the separate band-spread ad-

justments may be made without changing the general coverage alignment.

The four screws must be shifted to the right-hand terminal blocks, as outlined under "Coil Ranges" in the preceding section. The tuning dial is set at 450 and a test oscillator adjusted to the exact high-frequency edge of the proper amateur band. Trimmer No. 7 of (the top view) is adjusted until the signal is picked up. Trimmers Nos. 1, 3 and 5 are then adjusted for maximum sensitivity. The dial is then rotated to the low-frequency end of the band; that is, to 50; and the right-hand calibration curve should be checked. If found incorrect, it will be necessary to adjust the band-spread series padding condenser, mounted inside the oscillator coil and adjustable from the rear by means of a screw driver. If the low-frequency end of the band is tuned in at any dial reading above 50, the capacity of this series padding condenser must be decreased. If the low-frequency edge of the band is found between 0 and 50, the capacity must be increased. The setting is critical. After making a trial adjustment, the dial is returned to 450 and trimmer No. 7 readjusted. The above procedure is repeated until the dial checks the calibration curve.

Tracking of the two R.F. and first detector circuits may then be checked by tuning to the low-frequency end of the band and checking the adjustment of the Nos. 1, 3 and 5 trimmers. If more capacity is needed for best sensitivity (as

indicated by improved signal strength when the trimmer is rotated clockwise), the series padding condenser of the coil being adjusted must have more capacity. If any of the Nos. 1, 3 or 5 trimmers require less capacity, a corresponding decrease must be made in the capacity of the series padding condenser. After the series padding condenser has been adjusted for trial, the dial is returned to 450 and the procedure repeated.

The above instructions may seem complicated, but they cover complete alignment under the worst possible conditions, where everything is out of adjustment. The chances are that the only adjustments that will need to be made are the conventional trimmer adjustments of the trimmers Nos. 1 to 8.

Simple antenna compensation for the general coverage range is made by adjusting trimmer No. 2, and for the bandspread range by adjusting trimmer No. 1.

The instructions will probably be simplified after reading the general description of the tuning system given in the last section of this booklet.

With regard to the coil groups covering the frequencies between 2.05 megacycles and 50 kilocycles, there are only five trimmer adjustments. These are Nos. 2, 4, 6, 7 and 8. The No. 8 adjustment is used here as in the other coils for adjusting the oscillator circuits to correspond with the calibration. The No. 7 trimmer is the conventional series padding adjustment. Nos. 2, 4 and 6 are the usual trimmers.

I.F. and Crystal Alignment Instructions

Before attempting to check the alignment or adjust a single signal receiver it is essential that the operator be familiar with the principles involved and the type of performance to be expected.

A receiver of this type is simply a superheterodyne which may be adjusted to have extremely high selectivity on all signals. The effective width of the selectivity curve is only a few cycles, usually between 20 and 100. This means that when tuning in a given c.w. signal, tuning is going to be very sharp and the dial must be turned slowly in order to avoid missing the signal entirely. As compared to the straight superheterodyne, the single signal receiver is about 100 times as selective. The straight super will pick up a signal and will reproduce both sides of the audio beat note at about the same strength; that is, the carrier whistle may be varied from either side of zero beat up to about 3000 cycles when the receiver is tuned and the whistle will remain about the same strength at any pitch. The s.s. receiver, however, being 100 times as sharp, will not perform in this manner, but as the receiver is tuned across the carrier the audio response will be very sharply peaked at one certain pitch of the carrier whistle. Detuning the receiver a small fraction of a degree, while it changes the pitch only slightly,

will make the signal much weaker, since it has been detuned from the sharp selectivity peak.

It is evident, therefore, that the great selectivity available shows up as a peak in the audio response and when the receiver is in operation all signals, after being correctly tuned, will peak at the same audio frequency.

General Superheterodyne Theory and the Explanation of Single Signal Operation

(It is extremely important that these paragraphs be very carefully studied, if a full understanding is to be had of the detailed data on adjusting Single Signal receivers)

To those who are not entirely familiar with the operating principles of a superheterodyne, the following explanation may be of interest:

It is the function of the first detector and high frequency oscillator of a super to convert a high frequency signal to the frequency of the intermediate amplifier. If, for instance, a 7000-k.c. signal is being received, the high frequency oscillator, in the case of the HRO receivers, will be tuned to 7456 k.c. producing a beat with the signal equal to the difference between these two frequencies; that is, 456 k.c., the frequency of the I.F. amplifier. The 456-k.c. beat is amplified in the I.F. amplifier and is detected or de-modulated in the case of phone signals at the second detector. When receiving c.w. signals a beat note is obtained by the use of a separate beat oscillator coupled to the second detector and operating at, or close to, the intermediate frequency. If the beat oscillator is tuned exactly to 456 k.c. and if the signal mentioned above is tuned to give an I.F. beat of exactly 456 k.c., it is evident that the receiver as a whole will be tuned to zero beat.

An audible beat note may be obtained by doing either one of two different things. The first is to change the tuning of the high frequency oscillator (by means of the tuning dial) slightly, so that it will produce a different I.F. beat with the signal. For example, suppose the dial is changed so that the high frequency oscillator oscillates at 7457 k.c.; the I.F. beat will now be 457 k.c., which will be amplified as before by the intermediate amplifier, but when reaching the second detector will produce a 1 k.c. (thousand cycle) audio beat with the beat oscillator, which is operating at 456 k.c. as before. Similarly, the tuning dial could be moved in the other direction, so that the high frequency oscillator is tuned to 7455 k.c., in which event the I.F. beat would be 455 k.c. and the audio beat note would be a thousand cycles but on the other side of the carrier.

The selectivity of the I.F. amplifier is such that a signal detuned from it by only one kilocycle (.2 of 1%) will still be amplified **almost** as much as a 456-kc. signal, although there will, of course, be some loss in gain.

The other method of getting an audible beat

note is to leave the signal tuned exactly, as in the original case, with the 456-k.c. I.F. signal but to detune the beat oscillator so that it operates at say 457 k.c. The I.F. amplifier is now exactly in tune with the I.F. signal and will amplify it at full efficiency. The beat note will be 1000 cycles, as before. This method, wherein the signal is tuned exactly and the beat obtained by detuning of the beat oscillator, is fundamentally that used in any single signal or semi-single signal receiver. It is evident that changing the tuning dial slightly will detune the I.F. signal from the I.F. amplifier so that it will not be amplified as much, causing a corresponding decrease in the strength of the audio beat note: thus, if tuning is changed in such a way as to raise the pitch of the beat note, the signal will be weaker. Similarly, if the tuning is changed to lower the pitch down toward the zero beat region, the signal will be weaker. If the tuning is still further changed, so that the audio note passes through the zero beat region, and "up the other side of the carrier," the signal will become weaker still. The falling off in signal strength, as the receiver tuning is changed, is due entirely to the selectivity of the I.F. amplifier. Suppose now that the I.F. amplifier has very high selectivity, as is the case when a crystal filter is employed in single signal reception; the crystal will pass only a very narrow band of frequencies, say from 455.9 k.c. to 456.1 k.c. It will be necessary, therefore, to tune the signal so that the I.F. beat is exactly 456 k.c., and in order to obtain an audible beat note, the beat oscillator MUST be detuned. If the beat oscillator is set as before at 457 k.c., the beat note will be 1000 cycles. Detuning, as in the above case, will make the signal practically inaudible, except at this one pitch, and "the other side of the carrier," or audio image, will be almost entirely suppressed.

With the receiver tuned exactly so that the crystal will pass the I.F. beat, the beat oscillator may be adjusted to give any desired audible beat note. In the above case, the beat oscillator being set at 457 k.c. produced a 1000-cycle beat at which all signals would be peaked. If the beat oscillator were set at 458 k.c., all signals would be peaked at 2000 cycles.

If the receiver tuning is left alone, then, the beat oscillator may be adjusted to give any desired pitch without changing the signal strength. Any change in tuning which changes the pitch of the audio signal will greatly weaken the signal.

The main point to remember when considering single signal receivers is that they are simply ultra selective superheterodynes, which must be tuned exactly to the signal and that the beat oscillator must be detuned from the crystal frequency in order to obtain an audible beat note.

Preliminary Adjustments — The I.F.

From the above explanation, the reader will see that it is absolutely essential that the I.F. transformers be aligned to the crystal, since the two must work together. This alignment may be accomplished in a number of ways. If the I.F. transformers are far out of adjustment, it is necessary to connect an external crystal oscillator which uses the crystal from the receiver. This oscillator is put in operation and is coupled to the first detector of the receiver. In most cases no actual connection will be required since the field from the oscillator will be sufficiently strong to be picked up, even with the I.F. far out of adjustment. If coupling is required, a lead twisted around the grid cap of the detector tube and run near the oscillator tank coil, will be suitable. The beat oscillator is turned on and adjusted until the crystal signal is picked up. The pitch of the beat note is not important as long as it is well inside the audible range.

All the I.F. transformers are now adjusted for maximum signal. This adjustment need not be made with any great degree of precision, since the crystal will not oscillate at exactly the same frequency to which it will be resonant in the receiver. The phasing control should be set at "0".

The five I.F. adjustments are indicated on the top view, Nos. 10 to 14 (inclusive).

The crystal filter output coupling condenser, adjustment No. 9, serves as a fixed I.F. gain control and, in general, **should not** be touched.

The crystal may now be removed from the oscillator and installed in the receiver. Throw the switch to connect the crystal for single signal reception. Set the selectivity control for maximum selectivity; that is, with the pointer rotated all the way to the right. Now, tune in a steady signal from a local oscillator or monitor. Tuning very slowly across the carrier, there should be one point at which the signal will peak very sharply. The audio pitch of this peak will be nearly the same as the pitch of the beat used when the crystal oscillator was being picked up.

The Beat Oscillator

Once the peak has been found, it would be well for the operator to familiarize himself with the action of the beat oscillator control by changing its tuning in order to obtain an audio note which is most pleasing to copy, or which coincides with any peaks in the loudspeaker or headphones. It makes little difference to which side of the audio beat the beat oscillator is tuned. After a satisfactory pitch has been found, tune the signal by means of the tuning dial so that the signal goes down through zero beat and up to approximately the same pitch on the other side. This response is, of course, much weaker than that of the peak and it may be necessary to turn up the volume control in order to obtain fair volume. The phasing, or

balancing, condenser is now adjusted until the signal is WEAKEST.

The Selectivity Control

The action of the selectivity control may now be checked. With the receiver tuned exactly as it was when adjusting the phasing condenser, the selectivity control should be rotated and it will be found that the signal will be loudest at a certain setting. This setting is usually found with the pointer nearly vertical. The setting giving this maximum response is that at which the selectivity of the crystal filter is minimum. Since even at this minimum selectivity the crystal filter is much more selective than the straight super, the signal will be weaker than that obtainable when the crystal is cut out.

When a pure steady signal is carefully tuned to a single signal peak, the selectivity control should have practically no effect upon signal strength. If there is any form of modulation, however, the signal will be loudest when the selectivity control is set for minimum selectivity, since this adjustment allows a greater width of signal or modulation to be passed.

Final I.F. Adjustment

The final adjustment of the I.F. transformers may now be made. Set the control for maximum selectivity, carefully tune in a steady signal until it is exactly on the crystal peak, and adjust each of the I.F. transformer tuning condensers for maximum signal strength. In almost all cases where the I.F. amplifier has once been aligned to the crystal, this check is all that would be required, and it is not necessary to put the crystal in an external oscillator. Even if the I.F. amplifier is considerably out of alignment, the crystal frequency may be found by employing a strong local signal from a monitor or frequency meter, slowly tuning across it while listening for a peak in the audio beat note. If the peak is found at a very high audio pitch it will be necessary to change the tuning of the beat oscillator so that the audio peak will be well inside the limits of audibility. It is probable that if the peak signal is found

at all, the I.F. amplifier will not be far out of tune and the readjustments required will be small.

Where the I.F. transformers are tuned with air dielectric condensers, the adjustments when once made are permanent and need only be checked when new tubes are substituted, provided of course the receiver is not subjected to severe mechanical shocks or vibration. I.F. transformers tuned by compression type mica dielectric condensers, on the other hand, should be checked frequently, since the capacity of such condensers is changed by temperature and humidity fluctuations. These statements are equally applicable to the beat oscillator circuits.

Checking Crystal Action

The crystal response, or crystal activity, may be easily checked as follows: With the signal tuned in exactly as mentioned in the previous paragraph and the selectivity control set at maximum selectivity, disconnecting the filter (by turning the phasing knob to "0"), should weaken the signal slightly. There will, of course, be a great increase in tube hiss, background noise and interfering signal, but the actual strength of the desired signal should be weaker. It is possible, of course, to obtain a louder signal in the straight super connection by resetting the selectivity control and this is quite normal. The fact that a signal is weakened when using the crystal filter is relatively unimportant, inasmuch as the filter is only used when interference or static is present, and such interference will be made about 100 times weaker, thereby greatly improving the readability of the signal.

A crystal which is found to be a poor resonator should be carefully removed from the holder and both crystal and plates cleaned with alcohol, gasoline, carbona, ether, or some similar fluid. In reassembling the holder care must be taken to see that the crystal is free between the plates; that is, that there is a suitable air gap (usually two or three thousandths) between the plates and the crystal and that the crystal is free to move sideways in any direction. The fibre pieces may be removed if desired as they serve only to protect the crystal in shipment.

The I.F. transformer illustrated at the right has two air dielectric condensers isolated from each other by an aluminum shield and mounted on a low loss ceramic base. The coils are Litz wound on a polystyrene form and thoroughly impregnated with liquid Victron.

These features contribute to the exceptional stability of the HRO and account in one detail for its acceptance as the communication receiver ideal for long periods of peak performance under adverse conditions and in all types of climate.

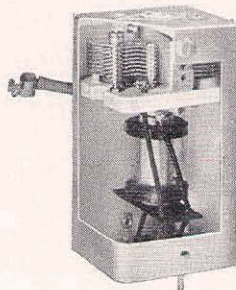

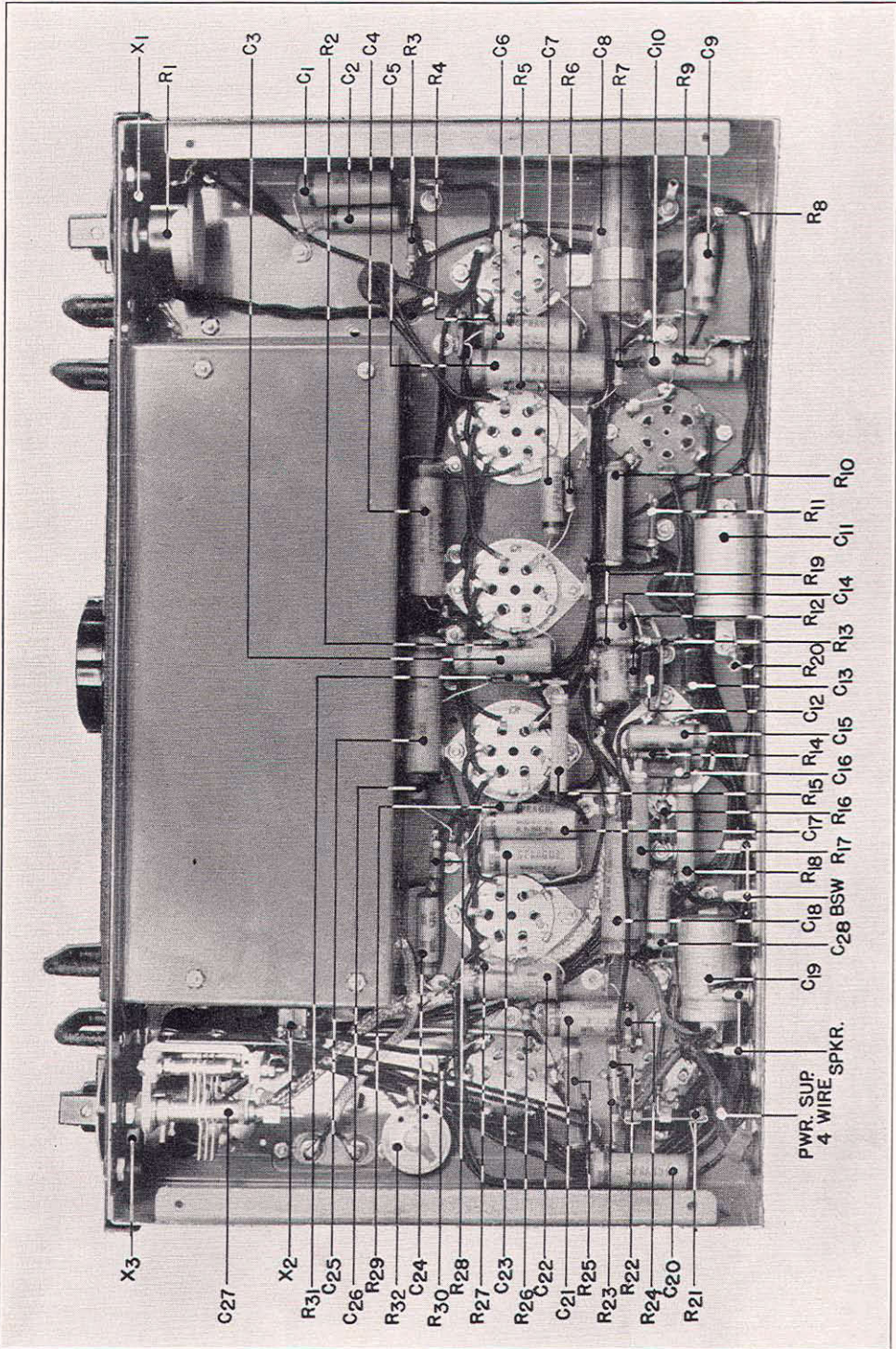

BOTTOM VIEW HRO

Resistor & Condenser List

R ₁	R.F. Gain Control	10,000	ohms	Variable
R ₂	1st Detector Bias Resistor	5,000	"	1/2 Watt
R ₃	1st I.F. Grid Filter Resistor	500,000	"	1/2 Watt
R ₄	1st I.F. Bias Resistor	300	"	1/2 Watt
R ₅	H.F. Osc. Screen Resistor	50,000	"	1/2 Watt
R ₆	1st Det. Screen Resistor	100,000	"	1/2 Watt
R ₇	H.F. Osc. Bleeder Resistor	100,000	"	1/2 Watt
R ₈	2nd I.F. Grid Filter Resistor	500,000	"	1/2 Watt
R ₉	2nd I.F. Bias Resistor	1,000-5,000	"	1/2 Watt
R ₁₀	R.F. and I.F. Screen Resistor	15,000	"	2 Watt
R ₁₁	S-Meter Bridge Resistor	250-2,500	"	1/2 Watt
R ₁₂	2B7 Pentode Grid Resistor	500,000	"	1/2 Watt
R ₁₃	Diode Filter Resistor	50,000	"	1/2 Watt
R ₁₄	Diode Equalizing Resistor	250,000	"	1/2 Watt
R ₁₅	Screen Bleeder Resistor	30,000	"	2 Watt
R ₁₆	Pentode Screen Bleeder Resistor	20,000	"	1/2 Watt
R ₁₇	Pentode Screen Resistor	100,000	"	2 Watt
R ₁₈	Pentode Plate Resistor	100,000	"	2 Watt
R ₁₉	AVC Filter Resistor	500,000	"	1/2 Watt
R ₂₀	2B7 Bias Resistor	800	"	1/2 Watt
R ₂₁	Heater — Center-Tapped Resistor	60	"	
R ₂₂	CW Osc. Screen Resistor	250,000	"	1/2 Watt
R ₂₃	CW Osc. Plate Resistor	100,000	"	1/2 Watt
R ₂₄	CW Osc. Screen Bleeder Resistor	100,000	"	1/2 Watt
R ₂₅	Output Pentode Bias Resistor	500	"	2 Watt
R ₂₆	Output Pentode Grid Resistor	500,000	"	1/2 Watt
R ₂₇	1st R.F. Bias Resistor	300	"	1/2 Watt
R ₂₈	1st R.F. Grid Filter Resistor	500,000	"	1/2 Watt
R ₂₉	2nd R.F. Bias Resistor	300	"	1/2 Watt
R ₃₀	S-Meter Bridge Resistor	0-2,000	"	1/2 Watt
R ₃₁	2nd R.F. Grid Filter Resistor	500,000	"	1/2 Watt
R ₃₂	S-Meter Balancing Resistor	1,000	"	Variable
C ₁	Heater By-pass Condenser	.1	mfd.	400 Volt
C ₂	1st I.F. Grid Filter By-pass Condenser	.01	"	400 Volt
C ₃	1st Det. Cathode By-pass Condenser	.1	"	400 Volt
C ₄	2nd R.F. B+ By-pass Condenser	.1	"	600 Volt
C ₅	H.F. Osc. Screen By-pass Condenser	.1	"	600 Volt
C ₆	1st I.F. Cathode By-pass Condenser	.1	"	400 Volt
C ₇	1st Det. Screen Coupling Condenser	.1	"	500 Volt
C ₈	I.F. B+ By-pass Condenser	.25	"	600 Volt
C ₉	2nd I.F. Grid Filter By-pass Condenser	.01	"	400 Volt
C ₁₀	2nd I.F. Cathode By-pass Condenser	.1	"	400 Volt
C ₁₁	2B7 Cathode By-pass Condenser	10.	"	50 Volt
C ₁₂	Diode Filter Condenser	.0001	"	Mica
C ₁₃	Diode Filter Condenser	.00025	"	Mica
C ₁₄	2B7 Grid Coupling Condenser	.1	"	400 Volt
C ₁₅	Diode By-pass Condenser	.01	"	400 Volt
C ₁₆	2B7 Plate By-pass Condenser	.0005	"	Mica
C ₁₇	2nd R.F. Cathode By-pass Condenser	.1	"	400 Volt
C ₁₈	Output Pentode Grid Condenser	.1	"	600 Volt
C ₁₉	Output Pentode Cathode By-pass Condenser	10.	"	50 Volt
C ₂₀	Heater By-pass Condenser	.1	"	400 Volt
C ₂₁	CW Osc. Screen By-pass Condenser	.1	"	400 Volt
C ₂₂	1st R.F. Cathode By-pass Condenser	.1	"	400 Volt
C ₂₃	R.F. and I.F. Screen By-pass Condenser	.1	"	400 Volt
C ₂₄	1st R.F. Grid Filter By-pass Condenser	.01	"	400 Volt
C ₂₅	1st R.F. B+ By-pass Condenser	.1	"	600 Volt
C ₂₆	2nd R.F. Grid Filter By-pass Condenser	.01	"	400 Volt
C ₂₇	CW Osc. Receiver Tuning Condenser	30.	mmf.	Variable
C ₂₈	2B7 B+ By-pass Condenser	.01	mfd.	600 Volt
X ₁	B+ (stand-by) Switch			
X ₂	CW Oscillator Switch			
X ₃	AVC On-Off Switch			

Design Notes on High Frequency Superhets

Matching, Tracking and Stabilizing Multi-Tuned Circuits

THE advantages of a multi-stage r.f. amplifier between the antenna and first detector of a superheterodyne receiver are well known to most amateurs. As repeatedly shown in *QST*, such an amplifier is essential to obtaining high effective sensitivity and a high signal-to-image ratio. Simple regenerative input circuits, while offering some aid, have definite limitations, as well as being difficult to tune and erratic in performance.

Offhand, it might be wondered that receivers employing one or two r.f. stages have not been more generally available to the amateur; but in the construction of such a receiver there have been many difficult design problems to overcome. It is unfortunate that the unquestioned advantages of a multi-stage r.f. amplifier between the antenna and first detector of a superheterodyne receiver cannot be realized in simple fashion.

Amateur-band superhets with pre-amplifiers have become standard, however; and since the receiver is of such primary importance in the amateur station, the design problems of this type of equipment are of no little interest. The principal problems relate to tracking of tuning, uniform gain, h.f. oscillator stability and adequately calibrated band-spreading.

Circuit Tracking and Uniform Gain

At the lower frequencies the circuit matching problem is relatively simple and requires only the usual precautions with regard to careful matching of coils and gang condenser sections. Above 10,000 kc., however, ordinary production methods cannot be used. Much greater precision is required. Not only are precisely adjustable trimmer condensers required in all circuits, but also some means must be employed for obtaining inductance trimming. For instance, it was found that the total length of wire in a 28-mc. tuned circuit (including condenser leads, etc.) must be held within one-quarter inch. One satisfactory method of inductance trimming is illustrated in Fig. 1A. The last half-turn of wire is brought out in a loop, normally at right angles to the rest of the coil. Bending the loop one way or the other gives an inductance variation equivalent to adding or subtracting a half-turn from the coil. The lower frequency coils can conveniently employ a different type of inductance trimmer, shown in Fig. 1B. As the disc is moved toward the center of the coil, the inductance is decreased.

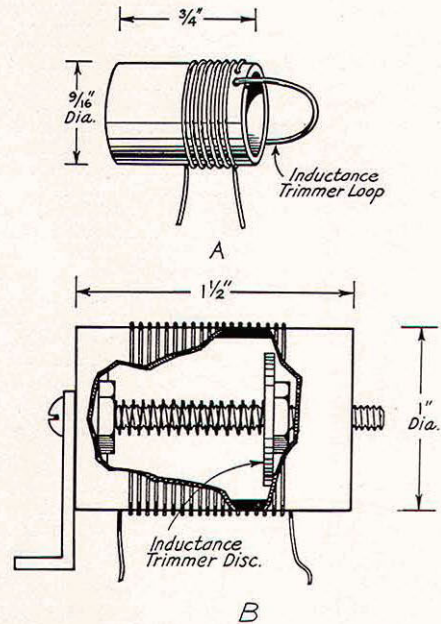

FIG. 1—INDUCTANCE TRIMMING METHODS
A—High-frequency coils.
B—Low-frequency coils.

Understanding of the electrical matching and tracking will be clarified by an explanation of the exact function of each of the somewhat imposing array of condensers associated with each stage in the diagram of Fig. 3. To begin with, the ganged main tuning condensers C_1 (those at the lower right-hand side of each group) have a capacity range determined by the widest frequency span required, namely, 4000 to 1700 kc. All the other variable condensers shown are built into the plug-in coil assemblies and are, therefore, adjusted individually in one range only. The condensers C_3 connected directly across the tuning condensers are the main trimmers, the purpose of which is to bring the minimum capacity of all circuits to the correct value. As far as the general coverage ranges are concerned, these trimmers, together with the oscillator series tracking condenser C_4 (shown just above the stator of the oscillator tuning condenser) and coils of the proper inductance, are all required for exact ganging.

When changing to amateur band-spread, two additional condensers are necessary in each circuit. The "A" contacts, being open, connect condenser C_5 in series with each tuning condenser, thus lowering the maximum capacity effective and limiting the tuning range so that the desired band is spread over the major portion of the dial. These condensers, now being in series with both the tuning condensers and the main trimmers, also cause the minimum capacity across the coils to be lowered considerably. With the "B" contacts closed, however, another condenser C_2 is connected in parallel with each of the coils, bringing the minimum capacity to the value required for properly centering the band on the dial.

The problem of obtaining uniform gain over ranges below 14 mc. is comparatively simple since it is only necessary to use high inductance primaries with the correct amount of capacity coupling. To those who are not familiar with this system of coupling, a brief explanation will be of interest. The primary winding has a large num-

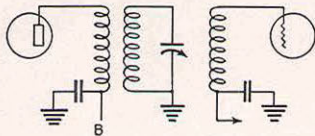

FIG. 2—TUNING ARRANGEMENT USED TO GIVE UNIFORM GAIN IN THE 14- TO 30-MC. RANGE

ber of turns of fine wire, so that it will be broadly resonant just below the low-frequency end of the tuning range. The point of resonance is determined by the circuit and plate capacity of the r.f. tube in parallel with the coil. The signal transfer from the tube to the primary will, therefore, increase as the resonant point is approached; in other words, as the tuning condenser is varied from minimum to maximum capacity. On the other hand, the impedance of the tuned circuit will decrease as the capacity is increased and at the low-frequency end will, therefore, require the additional signal which the primary is supplying.

It often happens, however, that the effect of the primary is predominant, resulting in higher gain at the low-frequency end. Additional compensation is obtained by a small amount of capacity coupling directly between the plate and the grid of the following tube. This coupling, being small, will have less effect at the low frequencies but will have a large effect at the high-frequency end, since the impedance of the coupling condenser decreases as the frequency is raised. This system of r.f. coupling is entirely satisfactory below 14 megacycles, but between 14 and 30 megacycles it is not effective. In this range the gain falls off rapidly and the resonance of the primary is inadequate in its levelling action.

The system finally devised to overcome this difficulty is il-

lustrated in Fig. 2. The primary plate winding is coupled as closely as possible to the tuned circuit, being interwound with it, and having the same number of turns. The grid winding is also closely coupled to the tuned circuit and consists of a large number of turns of fine wire, the coil itself being resonant just outside the low-frequency end of the range. This grid winding gives considerable voltage step-up and at the same time compensates for the varying impedance of the tuned circuit in such a way that the gain is uniform. It should be pointed out, however, that the grid coil itself is resonant and not the coil plus the circuit and the tube capacity.

The H.F. Oscillator

The third problem encountered in the design of wide range Single-Signal receivers is the high-frequency oscillator. The requisite degree of stability can be obtained through the use of a screen-grid tetrode or pentode in the oscillator. When used in the conventional electron-coupled circuit, however, the tetrode has one particularly objectionable characteristic; namely, it delivers to the first detector not only the desired fundamental frequency but also strong harmonics, the 2nd, 3rd, and 4th often being responsible for the reception of phantom signals, whistles, and for the aggravation of general noise. These harmonics are

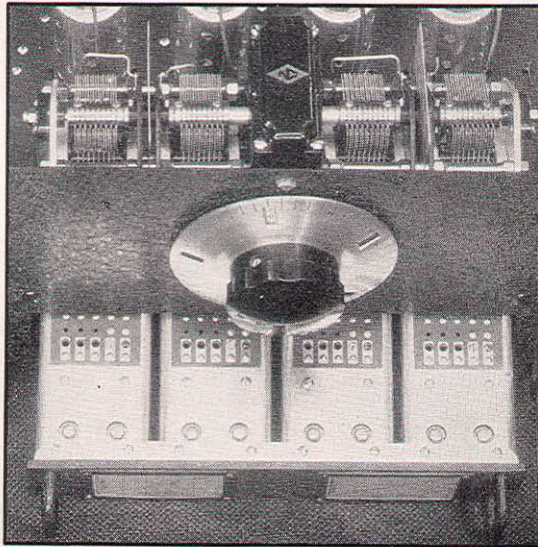

ESSENTIAL ELEMENTS OF THE MULTI-TUNED INPUT CIRCUITS DISCUSSED IN THIS ARTICLE

The shielded coil assembly (shown in front of the panel) plugs in beneath the condenser gang, four such assemblies being used for full frequency coverage.

much stronger (as compared to the fundamental) in the non-selective oscillator plate circuit than they are in the tuned grid-cathode circuit. Hence it is more desirable that the first detector should be coupled to some portion of the latter circuit,

a separate shielded compartment. The heat from the tubes will, of course, rise toward the top of the receiver and the coils will remain nearly at room temperature. The coil shielding must be complete, of course, to prevent convection air currents from

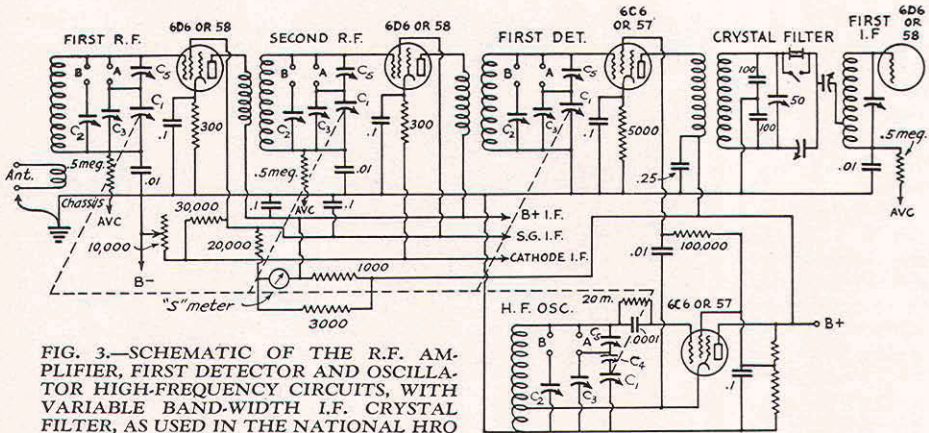

FIG. 3.—SCHEMATIC OF THE R.F. AMPLIFIER, FIRST DETECTOR AND OSCILLATOR HIGH-FREQUENCY CIRCUITS, WITH VARIABLE BAND-WIDTH I.F. CRYSTAL FILTER, AS USED IN THE NATIONAL HRO RECEIVER

The main tuning condensers C_1 are ganged. Other condensers of the high-frequency circuits are identified in the text. Resistance values indicated are ohms, capacitance values $\mu\text{fd.}$ (fractions) and $\mu\mu\text{fd.}$ (This is a preliminary diagram and is superseded by the one on page 4.)

rather than to the plate circuit. The electron-coupling feature, necessary to isolate the oscillator tuned circuit from the detector tuned circuit, can be obtained in the detector tube.

The circuit diagram of Fig. 3 shows the screen grid of the first detector capacity-coupled to the cathode of the oscillator. Coupling in this manner has the advantages of electron-coupling, inasmuch as the first detector screen is not directly associated with the tuned signal circuits. In addition to eliminating trouble from harmonics, this system has another important advantage; by correct placement of the cathode tap, the oscillator input to the detector may be held constant over the entire range. Incidentally, this coupling condenser serves a double purpose in that it also acts as an i.f. by-pass condenser.

Frequency drift in the oscillator becomes an increasingly difficult problem to solve as the range of the receiver is extended toward 10 meters. While variations in the room temperature are usually so gradual that drift resulting from this source is not objectionable, it is minimized through the use of padding and tuning condensers which are compensated against temperature change and through the use of material for coils which has a small temperature coefficient.

The cause of the most objectionable frequency drift is the change of inductance of the coil as the interior of the receiver is heated by the tubes and power supply. The chief offender, the power supply, fortunately can be a separate unit; but the tubes must remain in the receiver. To minimize heating the coils are placed at the very bottom of the receiver, underneath the chassis, in

coming in contact with the coils, as well as for good magnetic and electro-static shielding.

The oscillator must be of the Hartley type if the full advantages of the tetrode type of oscillator are to be utilized. The system described fulfills this requirement, in that all the tuning devices are connected across the whole coil. This is im-

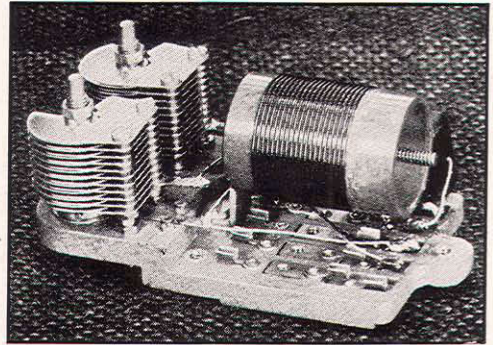

A MEDIUM-FREQUENCY R.F. COIL UNIT REMOVED FROM ITS SHIELD

portant. If, for instance, the tuning condenser is connected across only a portion of the coil, the circuit tends to become unstable and the frequency will change with variations in the line voltage. In receivers employing separate coil units for the general coverage and band-spread ranges, however, it is permissible to use extremely high "C" circuits to obtain stability.

Probably as the result of broadcast receiver

practice, many short-wave receivers have been designed with the idea of covering the greatest possible range with the fewest coils, with the individual coil ranges determined entirely by the size of the tuning condenser. This is hardly satisfactory for amateur work since unfavorable L/C ratios and non-uniform band spread result, and the operator must refer to calibration charts in order to locate, even approximately, any amateur band. In the tuning system under consideration, the coil ranges are chosen so that each just covers two amateur bands, one at either extremity of the range. For instance, the highest frequency range starts just above 30 megacycles and extends to just below 14 megacycles; the next range starts just above 14.4 megacycles and extends to just below 7 megacycles; and so on. For general coverage it is thus possible to tune through any two adjacent bands without change of coils.

Furthermore, any coil unit may be used alternatively for either general coverage or calibrated amateur band spread. As indicated in the circuit diagram of Fig. 3, there are two pairs of contacts in each tuning circuit. When the "A" contacts are connected, the general coverage ranges will be as described above. When the "A" contacts are open and the "B" contacts closed, two circuit changes are made: a small condenser is connected in series with the main tuning condenser thus reducing its capacitance range; and an additional trimmer condenser is connected across the coil, thus increasing the minimum circuit capacitance. These condensers are of such size that, when in use, full band spread will be obtained on any amateur band. For instance, changing the contacts from "A" to "B" on the 30- to 14-megacycle coils will give full band spread on the 30- to 28-mc. amateur band.

There are several advantages to this system, the first and most obvious being a positive, unchanging and uniform calibration for each of the band-spread ranges. The condensers are, of course, adjusted so that each band has the same spread on the dials. There is still another advantage which is not readily apparent from an inspection of the diagram; namely, that it is possible to obtain straight-frequency-line tuning on both band-spread and general coverage ranges. It will be noted that one trimmer condenser is connected directly across the tuning condenser while the other is connected across the coil terminals with the "B" contacts in series. With the "A" contacts connected ("B" open) the first mentioned trimmer is directly across the coil and serves as a conventional padding condenser. The plates of the main tuning condenser are shaped so as to give straight-frequency-line tuning on the full coverage ranges. With the "A" contacts open and "B" closed, this trimmer is effective only in increasing the minimum capacity of the tuning condenser and by so doing gives practically straight-frequency-line tuning on the band-spread ranges also.

Mechanical Considerations

So far we have discussed principally the electrical considerations involved. The mechanics of the tuning arrangement, together with the condenser and coil construction, are fully as important.

A good tuning system should be convenient to operate and this requirement necessitates the use of a positive vernier drive in order that band-spread tuning may be obtained at any point in the frequency range. A little thought will show that band-spread tuning is always obtained through a combination of mechanical and electrical devices. While continuous band spread might seem possible mechanically with a condenser drive of sufficient reduction, in practice large reduction is not easy to obtain without introducing backlash, or without sacrificing accuracy of calibration.

In the mechanical section of the tuning system under consideration the tuning condensers are driven through a worm gearing, spring-loaded to take up backlash and wear. The main dial is mounted directly on the worm shaft and is rotated ten times for 180° rotation of the condensers. The auxiliary dial numbers appear through windows in the main dial shell and are changed automatically every revolution of the dial by means of an epicyclic gearing so that the calibration is numbered consecutively from 0 to 500. The actual useful length of the equivalent scale being twelve feet. The result is that signals are well spread out on the scale, even on the general coverage ranges, making tuning and logging both convenient and precise. With the coil connections shifted to give full spread on any amateur band the character of the system is especially striking. The 14-mc. band, for instance, is given 400 dial divisions, which, since the band is 400-ke. wide, means that the tuning rate is 1000 *cycles* per dial division. This feature will be especially appreciated by anyone who is accustomed to tuning the Single-Signal receiver with the crystal circuit adjusted for maximum selectivity.

Gain Control and Strength Meter

We come now to the matter of r.f. gain control. While no unusual difficulties are presented, the multi-stage r.f. amplifier offers the designer an opportunity to overcome problems which are bothersome in simpler receivers. In order to obtain the best signal-to-noise ratio the first tube should be operated at maximum gain. This is especially important for weak signal reception. When two tubes precede the first detector, the manual r.f. gain control may be connected only to the second r.f. tube (and to the i.f. tubes) with a decided gain in weak-signal performance. The a.v.c. circuits are, however, connected to both r.f. stages, so that strong signals will be held more closely to the same output level. Such a combination of a.v.c. and manual control makes possible accurate "S-meter" measurement of the carrier strength of any receiver signal.

AVERAGE CHARACTERISTICS

Total primary current at 115 Volt-60 cycles:

Using Type 697 power pack: .6 amperes

Using Type 5886 power pack: .4 amperes

Sensitivity: 1. microvolt input through IRE standard dummy antenna to deliver 2.0 watts output with a 7000 ohm load.

Selectivity:

Crystal filter off:

Ratio	Bandwidth K.C.
2	3.0
10	7.5
100	14.0
1000	21.5

Crystal filter in:

Max. selectivity — effective total width 200 cycles

Min. selectivity — effective total width 2.5 K.C.

C.W. Noise Equivalent: .2 microvolt

Signal-to-Noise Ratio at 5 microvolts: 16 db.

(Ratio of output, with 30% modulation ON/OFF)

Input Impedance at Antenna Terminals: 500 ohms (average)

Maximum Undistorted Power Output: 1.5 Watts.

AVC Characteristic: Flat within \pm 10 db. between 1.0 and 100,000 microvolts.

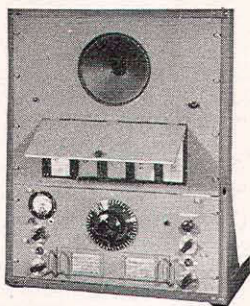

HRO-SPC

A complete self-contained receiver is the unit pictured at the left. It consists of a panel mounted HRO receiver, an SPC unit and an MRR relay rack. The SPC unit combines the power supply, speaker and five compartment coil storage cabinet.

HRO panel height $8\frac{3}{4}$ " ; SPC panel height $15\frac{3}{4}$ " ; panel capacity $24\frac{1}{2}$ ".

Prices on page 19.

HRO JUNIOR

The HRO Junior is identical to the HRO standard receiver in its circuit and mechanical details but is lower in price due to the omission of the crystal filter, signal strength meter and bandsread coils. As standard equipment it is supplied with tube lineups the same as the HRO and has one set of general coverage coils which covers from 14 to 30 megacycles providing reception on both the 10 and 20 meter amateur bands.

Its power supply requirements are identical to the corresponding HRO standard types.

On special order, bandsread and low frequency HRO type coils can be adjusted for operation in an HRO Junior receiver.

TYPE HRO RECEIVER

HRO Standard A.C. table model, or HRO-B battery operated, complete with tubes and four sets of coils covering from 1.7 to 30 M.C., less speaker and power supply. *List Price, \$299.50*

HRO and HRO-B, same as above, but mounted on a 3/16" aluminum panel finished in either black leatherette or gray enamel for relay rack mounting.

List Price, \$320.00

HRO Junior or HRO-B Junior, table model, with tubes and one set of 14 to 30 M.C. coils, less speaker and power supply. *List Price, \$180.00*

HRO Junior models, same as above, but panel mounted similar to the rack model HRO. *List Price, \$200.00*

ACCESSORIES

HRO Junior Coils ranges, General Coverage Only

JA 14-30 M.C. *List Price, \$16.50*

JB 7.0-14.4 M.C. *List Price, \$16.50*

JC 3.5-7.3 M.C. *List Price, \$16.50*

JD 1.7-4.0 M.C. *List Price, \$16.50*

HRO Bandsread coils, any standard short wave range. *List Price, \$20.00*

Additional HRO Coils, General Coverage Only

J 50-100 K.C. *List Price, \$37.50*

H 100-200 K.C. *List Price, \$30.00*

G 175-400 K.C. *List Price, \$27.50*

F 500-1000 K.C. *List Price, \$20.00*

E 900-2050 K.C. *List Price, \$20.00*

MCS Table model metal cabinet and 8" P.M. Dynamic Speaker with 7000 ohm matching transformer. *List Price, \$16.50*

RFSH (speaker as above), rack mounted on 8 $\frac{3}{4}$ " aluminum panel. *List Price, \$30.00*

SPC Combination — 8" P.M. dynamic speaker, power supply (standard specifications) and coil storage compartment for five coils. *List Price, \$90.00*

MRR table relay rack, panel capacity 24 $\frac{1}{2}$ ", gray or black as used with combination of HRO and SPC units. *List Price, \$22.50*

HCRP Rack mounted coil storage compartment for five HRO coils. *List Price, \$27.50*

POWER SUPPLIES (115 Volt 50-60 cycle A.C. operation.)

Type 697 Table Pack — for 6.3 volt tubes, 230 volts, 75 m.a., with tube. *List Price, \$26.50*

Type 5886 Table Pack — for 6.3 volt tubes, 170 volts, at 50 m.a., with tube. *List Price, \$29.50*

Type 686 Table Pack — for 6.3 volt tubes, 165 volts, at 50 m.a., with vibrator. *List Price, \$45.00*

Type GRSPU Single Pack, rack mount supplied with same characteristics as 697 or 5886, with tube. *List Price, \$49.50*

Type GRDPU Double Pack, rack mount same characteristics as GRSPU but with two separate and complete power supplies, with tubes. *List Price, \$79.50*
230 volt A.C. or 25 cycle operation at slightly higher prices.

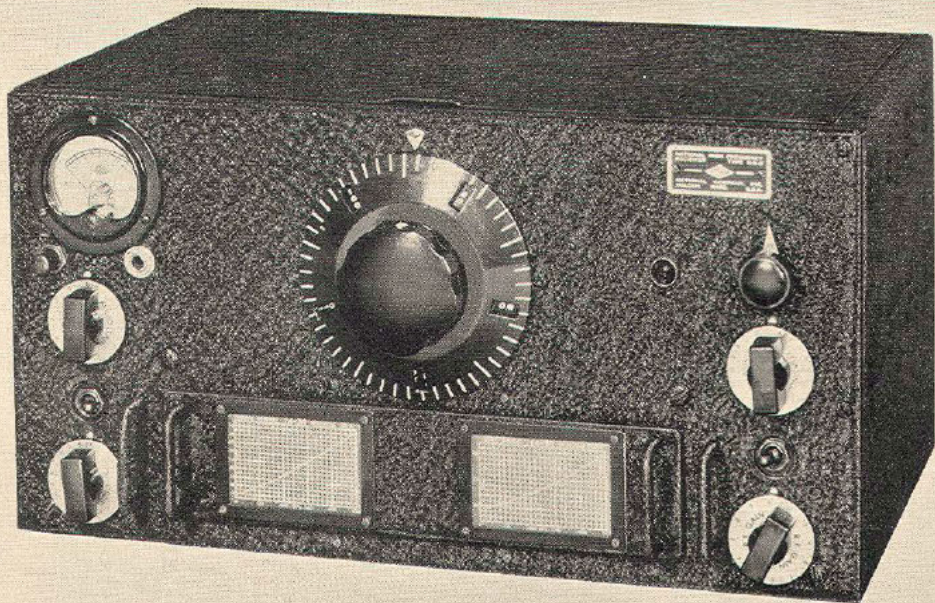

SINGLE SIGNAL

The completely shielded single signal unit has a front-panel selectivity control with sufficient range for phone reception, as well as a front panel phasing control for heterodyne elimination. The crystal is of a new type, virtually eliminating side peaks. The holder, also new, mounts the crystal vertically, permitting free oscillation. And when turned "off," the unit becomes a conventional I.F. coupling unit which contributes its full share to the remarkable overall selectivity of the HRO.

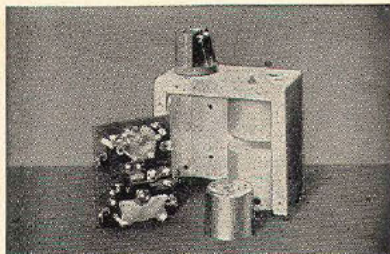

WORM DRIVE TUNING

The HRO employs the new PW precision condenser with worm-drive tuning. Smoother and more sensitive than a friction drive, it permits swift, accurate tuning and precise calibration. The micrometer dial has an effective scale length of twelve feet, direct-reading to one part in 500. The electrical characteristics are of the same high order, each of the four sections having low-loss Steatite stator insulation, insulated rotors and individual non-inductive rotor contacts.

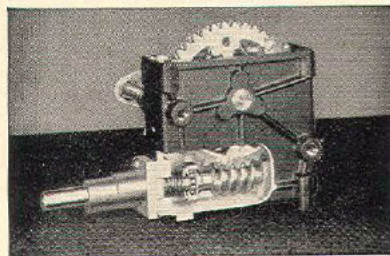

GANGED PLUG-IN COILS CALIBRATED BAND-SPREAD

The plug-in coils of the HRO are ganged for easy handling, and individually shielded for stability. Used as general coverage coils, each range includes two amateur bands and the spectrum between. By a simple switching device, the same coils are changed to band spread the respective amateur bands, spreading them over a uniform span of 400 divisions. All ranges are accurately calibrated at the factory.

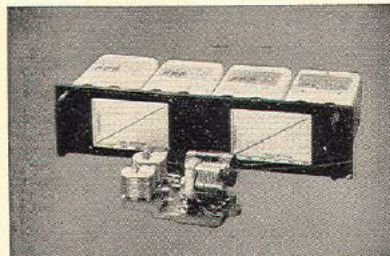

HIGH PERFORMANCE CIRCUIT

The nine-tube circuit employed in the HRO is remarkable for level gain from 1.7 to 30 mc. Two stages of tuned R.F. amplification preceding the tuned detector provide the notable signal-to-image ratio of 1000 to 1 at 14 mc., as well as exceptional usable sensitivity. The HRO is designed for either double or single wire antenna. Other features include separate audio and R.F. gain control, AVC, Beat Frequency Oscillator, Signal Strength Meter, Phone Jack and B-voltage switch.

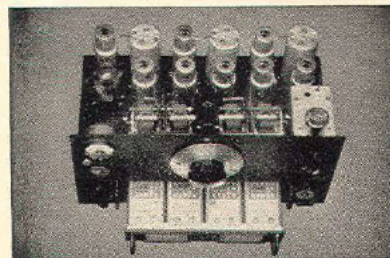

THE H R O

SINGLE SIGNAL SUPERHET



NATIONAL COMPANY
MALDEN, MASS., U.S.A.